

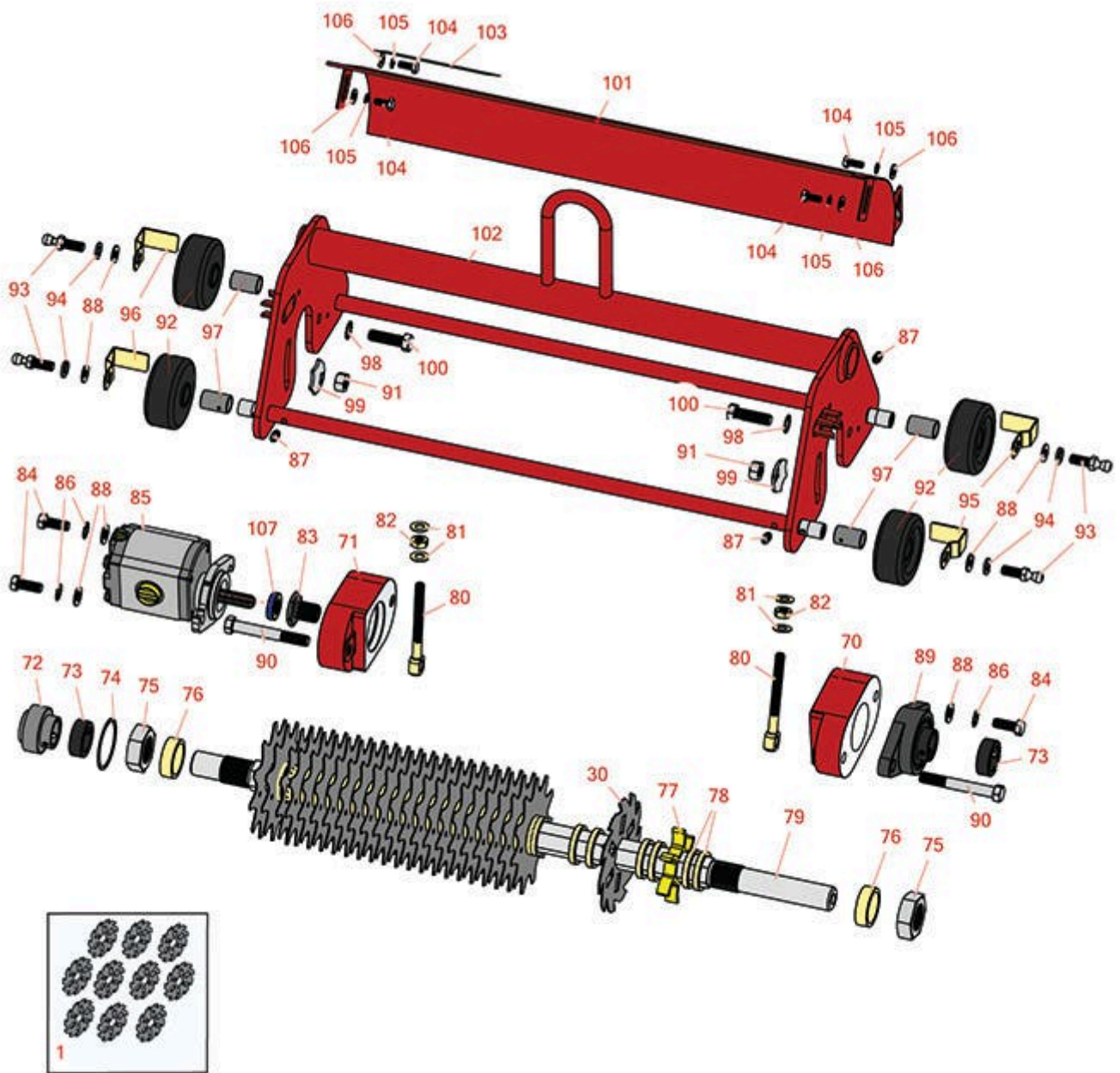

# Replaces Toro Greensmaster 300 Parts

Verti-Cut Unit - Model 04416

Verti-Cut Reel & Frame



All original equipment manufacturers names and part numbers are used for identification purposes only, and we are in no way implying that our products are original equipment parts. Prices subject to change without notice.



# Replaces Toro Greensmaster 300 Parts

Verti-Cut Unit - Model 04416

Verti-Cut Reel & Frame



Item No	R&R Part No.	OEM Part No.	Description	Qty Req	Order Quantity
---------	--------------	--------------	-------------	---------	----------------

## Overhaul Kits

1	<b>R106-6392</b>	106-6392	Verti-Cut Blade Kit - 2mm Carbide Tipped	0	
---	------------------	----------	--	---	--

*Tech Note: Includes Carbide Tipped Blades to rebuild 3 dethatching reels: 108 ea: R150209C Vertical Mower Blade:*

## Blades

30	<b>R17-1590</b>	17-1590	Verti-Cut Blade	36	
30	<b>R150209C</b>	106-6355	Verti-Cut Blade - Carbide Tipped 2mm	36	
30	<b>R150109C</b>	106-5422	Verti-Cut Blade - Carbide Tipped 1.2mm	36	

## Other Parts Available

70	<b>R17-1520</b>	17-1520	Weight - Counter V-Cut	1	
71	<b>R17-1610</b>	17-1610	Housing - Bearing V-Cut	1	
72	<b>R251-206</b>	251-206	Bearing	1	
73	<b>R251-77</b>	251-77	Collar - Bearing	2	
74	<b>R32120-77</b>	32120-77	Ring - Retaining	1	
75	<b>R3220-18</b>	3220-18, 67-5840	Nut - Jam V-Cut Shaft	2	
76	<b>R17-1580</b>	17-1580	Spacer - V-Cut Reel 1/2	2	
77	<b>R17-1600</b>	17-1600	Spacer - V-Cut Reel 1/4	72	
78	<b>R150230</b>		Spacer - 1/2 Ventilated V-Cut	36	
79	<b>R17-1570</b>	17-1570	Shaft - Hex Verti-Cut	1	
80	<b>R17-1510</b>	17-1510	Eyebolt	2	
81	<b>R17-1710</b>	17-1710	Washer - Flat 3/8 Yellow USS	4	

All original equipment manufacturers names and part numbers are used for identification purposes only, and we are in no way implying that our products are original equipment parts. Prices subject to change without notice.



# Replaces Toro Greensmaster 300 Parts

Verti-Cut Unit - Model 04416

Verti-Cut Reel & Frame



Item No	R&R Part No.	OEM Part No.	Description	Qty Req	Order Quantity
82	<b>R3217-7</b>	01-188-0616, 1441, 22-13-AJD, 3217-7, 513296, 513415, 513425, 915113P	Nut - 3/8-16 Hex Plated	4	
83	<b>R10-5100</b>	10-5100	Nut - Splined 1-1/8 Long	1	
83	<b>R93-1394</b>	93-1394	Nut - Splined RH Thrd .812 Long	1	
84	<b>R323-6</b>	01-150-0010, 01-178-0608, 20-47-AD, 20-47-AGD, 3224-2, 323-6, 49-3510, 908034P, 908332	Bolt - Hex HD 3/8-16 x 1 GR5 YZ	2	
85	<b>R105-9770</b>	10-5090, 105-9770, 26-5690, 70-9800, 94-3506, 94-3507	Hydraulic Motor - Reel Quick Release	1	
<i>Tech Note: Fits Models 3000, 3050 &amp; 3100:</i>					
85	<b>R120-2072</b>	100-6426, 108-6487, 112-9200, 120-2072, 93-1375	Hydraulic Gear Motor	1	
86	<b>R3255-9</b>	3255-9	Washer - Lock 3/8 Ext. Star	2	

All original equipment manufacturers names and part numbers are used for identification purposes only, and we are in no way implying that our products are original equipment parts. Prices subject to change without notice.



# Replaces Toro Greensmaster 300 Parts

Verti-Cut Unit - Model 04416

Verti-Cut Reel & Frame



Item No	R&R Part No.	OEM Part No.	Description	Qty Req	Order Quantity
87	<b>R302-5</b>	21-6010, 302-11, 302-37, 302-47, 302-5, 302-57, 302-58, 302-6, 31-0300, 32-9660, 60-0800, 62-3880, 92-4181	Fitting - Grease	4	
88	<b>R453011</b>	01-166-0100, 01-166-0120, 01-166-0270, 01-166-0500, 01-166-0600, 01-166-0620, 132-4593, 2356-3, 237-12, 24-10-AD, 24-11-AD, 24-11-BD, 24-12-AD, 24-12-BD, 30-9310, 32-8190, 3256-24, 3256-3, 3256-36, 3256-4, 453011, 47-9950, 48-9220, 513458, 7-0052	Washer - Flat 3/8 SAE Y/Zinc	2	
89	<b>R251-247</b>	251-247	Bearing - Flanged V-Cut Sft	1	
90	<b>R324-13</b>	324-13	Bolt - Hex HD 7/16 x 3-1/4	2	
91	<b>R443114</b>		Nut - 7/16 Hex Yellow Zinc	2	
92	<b>R17-1630</b>	17-1630	Wheel - Rubber Fits V-Cut Unit	4	

All original equipment manufacturers names and part numbers are used for identification purposes only, and we are in no way implying that our products are original equipment parts. Prices subject to change without notice.



# Replaces Toro Greensmaster 300 Parts

Verti-Cut Unit - Model 04416

Verti-Cut Reel & Frame



Item No	R&R Part No.	OEM Part No.	Description	Qty Req	Order Quantity
93	<b>R94-2958</b>	94-2958	Stud - Alloy Ball Joint	2	
94	<b>R3254-6</b>	01-166-0010, 01-166-0280, 01-166-0610, 3253-5, 3254-18, 3254-6, 3290-223, 48-9370	Washer - Lock 3/8	4	
95	<b>R17-1640</b>	17-1640	Scraper - Wheel LH	2	
96	<b>R17-1650</b>	17-1650	Scraper - Wheel RH	2	
97	<b>R17-1620</b>	17-1620	Bushing - Wheel	4	
98	<b>R3255-16</b>	3255-16	Washer - Lock 7/16 Ext Tooth	2	
99	<b>R3290-334</b>	3290-334	Washer - Lock Pyramidal	2	
100	<b>R324-6</b>	01-150-1690, 01-178-0712, 20-68-AGD, 3225-3, 324-6	Bolt - Hex HD 7/16-14 x 1-1/2	2	
101	<b>R17-1530</b>	17-1530	Shield - Grass V-Cut	1	
102	<b>R17-1450</b>	17-1450	Frame - V-Cut	1	
103	<b>R354083</b>	104-7729, 354083	Decal - Danger	1	
104	<b>R329-1</b>	329-1	Bolt - Hex HD 1/4-28 x 5/8	4	
105	<b>R3255-7</b>	3255-7, 76-5310	Washer - Lock 1/4 Ext Star Z	4	
106	<b>R3256-22</b>	24-9-BD, 3-1032, 3256-1, 3256-22, 93-0954, 93-0989	Washer - Flat 1/4 Yellow	4	

All original equipment manufacturers names and part numbers are used for identification purposes only, and we are in no way implying that our products are original equipment parts. Prices subject to change without notice.



# Replaces Toro Greensmaster 300 Parts

*Verti-Cut Unit - Model 04416*

*Verti-Cut Reel & Frame*



Item No	R&R Part No.	OEM Part No.	Description	Qty Req	Order Quantity
107	<b>R353-585</b>	353-585, 353-587, 354-34, 72-4380, 75-1210, 75-1270, 92-8863, 92-8864	Seal - High Pressure - Reel Motor	1	

All original equipment manufacturers names and part numbers are used for identification purposes only, and we are in no way implying that our products are original equipment parts. Prices subject to change without notice.