



Replaces Toro Greensmaster 300 Parts

4-Bolt Cutting Unit - Models 04404, 04405, 04406, 04407,

04408 & 04409

Reel & Bedknife

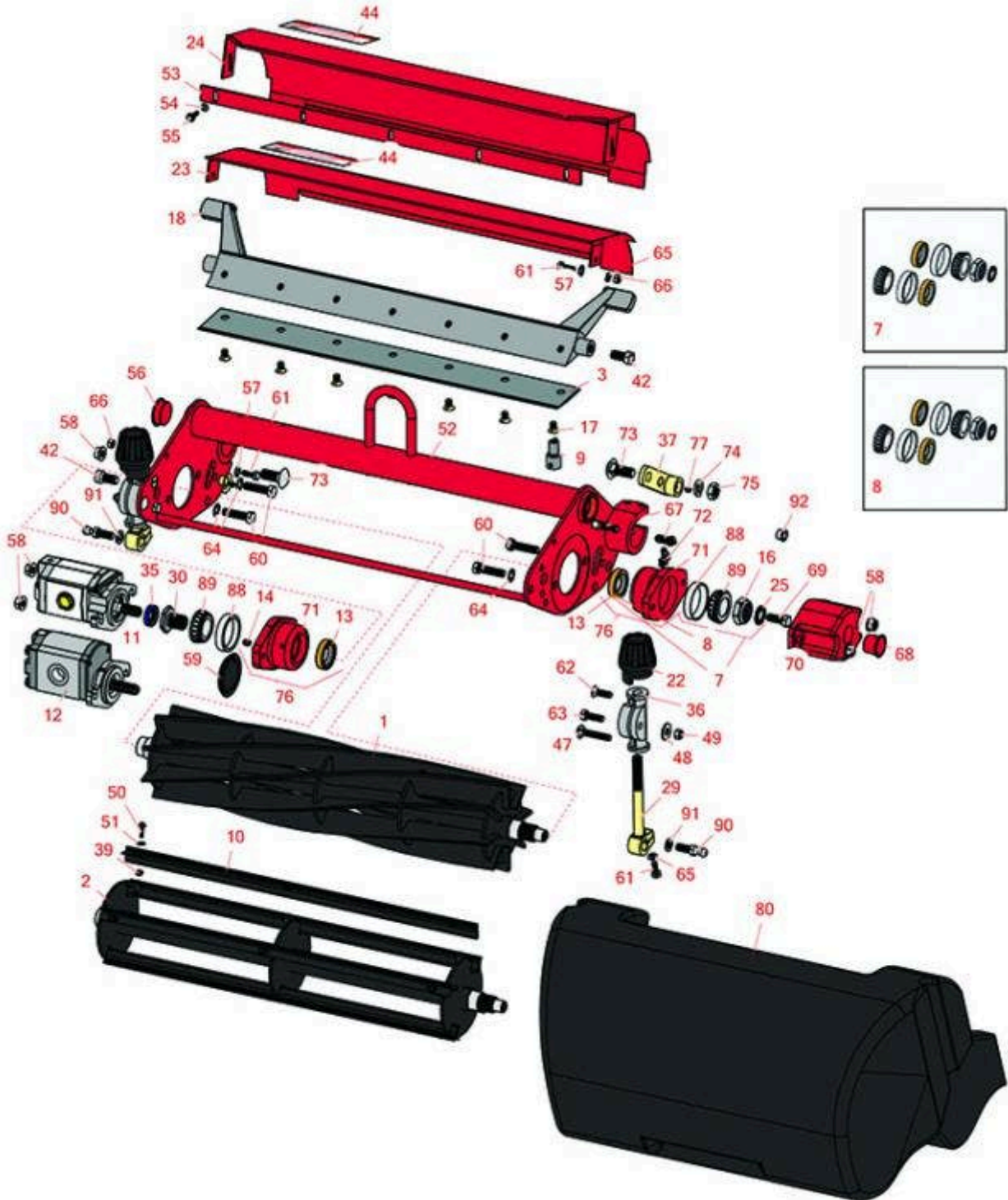

All original equipment manufacturers names and part numbers are used for identification purposes only, and we are in no way implying that our products are original equipment parts. Prices subject to change without notice.



Replaces Toro Greensmaster 300 Parts

4-Bolt Cutting Unit - Models 04404, 04405, 04406, 04407,

04408 & 04409

Reel & Bedknife



Item No	R&R Part No.	OEM Part No.	Description	Qty Req	Order Quantity
R&R Reels, Lifetime Guaranteed					
1	R5-3200	5-3200	Reel - 4 Blade	1	
1	R5-3205	12-0729, 12-8779, 5-3205	Reel - 5 Blade	1	
1	R5-3215	5-3215	Reel - 5 Blade Heavy Duty	1	
1	R14-0659	14-0659, 57-5300	Reel - 5 Blade Heavy Duty	1	
1	R5-3206	5-3206	Reel - 6 Blade	1	
1	R5-3189	12-3599, 130-6469, 5-3189	Reel - 8 Blade	1	
1	R14-0649	14-0649	Reel - 8 Blade Heavy Duty	1	
1	R5-3189H		Reel - 8 Blade Heavy Duty	1	
1	R5-3195	5-3195	Reel - 9 Blade	1	
1	R12-2789	12-2789, 130-6470	Reel - 11 Blade	1	
1	R150760		Reel - 14 Blade	1	
2	R150480		Brush Reel	1	
R&R Bedknives, Lifetime Guaranteed					
3	R150462	63-8610, 94-6396	Bedknife - 7 Hole Thick 5/16	1	
3	R93-4262	65-8250, 93-4262, 93-4263	Bedknife - Micro Cut .062 - .187 HOC	1	

All original equipment manufacturers names and part numbers are used for identification purposes only, and we are in no way implying that our products are original equipment parts. Prices subject to change without notice.



Replaces Toro Greensmaster 300 Parts

4-Bolt Cutting Unit - Models 04404, 04405, 04406, 04407,

04408 & 04409

Reel & Bedknife



Item No	R&R Part No.	OEM Part No.	Description	Qty Req	Order Quantity
3	R94-6394	51-2610, 63-8550, 94-6394	Bedknife - Tournament 1/8-1/2 HOC	1	
3	R63-8610	63-8610	Bedknife - Fairway Cut .375 - 1.00 HOC	1	
3	R94-6395	17-7040, 19-8880, 62-2510, 63-8500, 94-6395	Bedknife - Low Cut 3/16"-1" HOC	1	
3	R94-6396	10-4900, 54-9150, 94-6396, Oct-00	Bedknife - High Cut 5/16"-1" HOC	1	

R&R Razor Tool Steel Bedknives, Lifetime Guaranteed

3	R115-1881	115-1881	Bedknife - Razor Tool Steel - 21 Tournament Cut .125 - .500 HOC	1	
---	------------------	----------	---	---	--

Tech Note: Razor Tool Steel Bedknives are constructed from high grade tool steel for extended life and optimum cut.:

3	R115-1880	115-1880	Bedknife - Razor Tool Steel - 21 Micro Cut .062 - .187 HOC	1	
---	------------------	----------	--	---	--

Tech Note: Razor Tool Steel Bedknives are constructed from high grade tool steel for extended life and optimum cut.:

Overhaul Kits & Service Tools

7	R255-300	107-1590	Overhaul Kit - Cutting Unit	0	
---	-----------------	----------	-----------------------------	---	--

Tech Note: Includes 2 ea: R253-96 Seals, R254-72 Cups, R254-94 Bearings; 1 ea: R253-61 Seal, R32127-46 Locknut:

8	R107-1598	107-1598	Overhaul Kit - Cutting Unit	0	
---	------------------	----------	-----------------------------	---	--

Tech Note: Includes 2 ea.: R104-3388 Seals, R254-72 Bearing Cups & R254-94 Bearings; 1 ea: R253-61 Seal & R32127-46 Locknut:

9	R51-0880	51-0880	Bedknife Screw Driver Tool	0	
---	-----------------	---------	----------------------------	---	--

All original equipment manufacturers names and part numbers are used for identification purposes only, and we are in no way implying that our products are original equipment parts. Prices subject to change without notice.



Replaces Toro Greensmaster 300 Parts

4-Bolt Cutting Unit - Models 04404, 04405, 04406, 04407,

04408 & 04409

Reel & Bedknife



Item No	R&R Part No.	OEM Part No.	Description	Qty Req	Order Quantity
Other Parts Available					
10	R150481		Brush Assy - Brush Reel	4	
11	R105-9770	10-5090, 105-9770, 26-5690, 70-9800, 94-3506, 94-3507	Hydraulic Motor - Reel Quick Release	1	
<i>Tech Note: Fits Models 3000,3050 & 3100:</i>					
12	R120-2072	100-6426, 108-6487, 112-9200, 120-2072, 93-1375	Hydraulic Gear Motor	1	
<i>Tech Note: Fits Models 3150 & 3250-D:</i>					
13	R253-96	253-96	Seal - Oil Single Lip Reel	2	
13	R104-3388	104-3388	Seal - Double Lip Bearing Housing	2	
14	R302-5	21-6010, 302-11, 302-37, 302-47, 302-5, 302-57, 302-58, 302-6, 31-0300, 32-9660, 60-0800, 62-3880, 92-4181	Fitting - Grease	6	
16	R32127-46	32127-46, 3296-60	Locknut	1	
17	R150475	3-6462, 3-6642	Screw - Bedknife Stainless 5/16-18 x 5/8	7	

All original equipment manufacturers names and part numbers are used for identification purposes only, and we are in no way implying that our products are original equipment parts. Prices subject to change without notice.



Replaces Toro Greensmaster 300 Parts

4-Bolt Cutting Unit - Models 04404, 04405, 04406, 04407,

04408 & 04409

Reel & Bedknife



Item No	R&R Part No.	OEM Part No.	Description	Qty Req	Order Quantity
<i>Tech Note: Pre-Packaged in bags of 50:</i>					
17	R150476	3-3816, 3-6462, 52-4910, 57-4910	Screw - Bedknife 5/16-18 x 5/8	7	
17	R150477	57-4910	Screw - Bedknife 5/16-18 x 1/2	7	
18	R10-4930	10-4930, 10-4930-01	Bed Bar	1	
22	R65-8600	10-5040, 65-8600	Knob - Height Adjusting	2	
23	R27-2620	27-2620, Oct-40	Shield - Grass Deflector	1	
24	R36-7190	36-7190	Deflector - Grass	1	
25	R253-61	253-61	Seal - Oil Reel	1	
29	R10-5010	10-5010	Screw - Roller Adjustment	2	
30	R10-5100	10-5100	Nut - Splined 1-1/8 Long	1	
30	R77-0560	77-0560	Nut - Splined Fits Groomer	1	
30	R93-1394	93-1394	Nut - Splined RH Thrd .812 Long	1	
35	R353-585	353-585, 353-587, 354-34, 72-4380, 75-1210, 75-1270, 92-8863, 92-8864	Seal - High Pressure - Reel Motor	1	
36	R10-5060	10-5060	Bracket - Roller Adj	2	
37	R27-2650	27-2650	Height Adjustment Assy	2	

All original equipment manufacturers names and part numbers are used for identification purposes only, and we are in no way implying that our products are original equipment parts. Prices subject to change without notice.



Replaces Toro Greensmaster 300 Parts

4-Bolt Cutting Unit - Models 04404, 04405, 04406, 04407,
04408 & 04409
Reel & Bedknife



Item No	R&R Part No.	OEM Part No.	Description	Qty Req	Order Quantity
39	R3296-9	32127-17, 3296-9	Locknut - Comb	12	
42	R315298	217-74, 31-1070	Bolt - Bed Bar	2	
44	R354083	104-7729, 354083	Decal - Danger	1	
47	R441674	01-173-0514, 01-173-0516, 3-7253, 3230-5	Screw - 5/16-18 x 1-3/4 Carriage	2	
48	R453009	01-166-0400, 24-10-BD, 24-9-AD, 32-9650, 3256-2, 3256-23, 3256-3, 3256-67, 3290-217, 3556-3, 4-2390, 7-0152	Washer - Flat 5/16 SAE	6	
49	R32153-3	119-4038, 22-12-AJFD, 32127-35, 32146-5, 32153-3, 3296-18, 3296-29, 3296-31, N/A	Locknut - 5/16-18 ESNA Zinc	2	
50	R150425		Bolt - Hex HD 8-32 x 5/8	12	
51	R150426	3256-21	Washer - 8 SAE	12	
52	R70-1100	36-7230, 70-1100, 70-1100-01	Frame	1	

All original equipment manufacturers names and part numbers are used for identification purposes only, and we are in no way implying that our products are original equipment parts. Prices subject to change without notice.



Replaces Toro Greensmaster 300 Parts

4-Bolt Cutting Unit - Models 04404, 04405, 04406, 04407,
04408 & 04409
Reel & Bedknife



Item No	R&R Part No.	OEM Part No.	Description	Qty Req	Order Quantity
53	R36-7260	36-7260	Bar - Cut Off Grass Shield	1	
54	R3256-14	24-7-BD, 32125-2, 3256-14, 3256-51, 51-2170	Washer - 10 Flat	5	
55	R3290-237	3290-237	Screw - Hx Washer HD 10-24	5	
55	R32144-73	104-2065, 32144-73	Screw - Machine Hex Washer Head	5	
56	R285-14	285-14	Plug - Pipe Frame	2	
57	R3255-8	3255-8	Washer - Lock 5/16 Ext	2	
58	R3296-39	32127-25, 32128-36, 3290-357, 3296-17, 3296-22, 3296-39, 915663P, 99-7443	Locknut - 3/8-16 Nylon	2	
59	R150485	2410-30, 2410-30OSS	Cap - Protective Bearing Housing	1	
60	R3290-316	3290-316, 57-3210	Bolt - Hex Tap 3/8-16 x 1-1/2	4	
60	R323-53	323-53, 57-3210	Bolt - Hex HD 3/8-16 x 1-3/4	4	
61	R321-4	01-150-1030, 01-178-0406, 20-3-AGD, 321-4, 3222-1	Bolt - Hex HD 1/4-20 x 3/4	4	
61	R321-5	321-31, 321-5	Bolt - Hex HD 1/4-20 x 7/8	2	

All original equipment manufacturers names and part numbers are used for identification purposes only, and we are in no way implying that our products are original equipment parts. Prices subject to change without notice.



Replaces Toro Greensmaster 300 Parts

4-Bolt Cutting Unit - Models 04404, 04405, 04406, 04407,

04408 & 04409

Reel & Bedknife



Item No	R&R Part No.	OEM Part No.	Description	Qty Req	Order Quantity
62	R32108-20	32108-20	Screw - Flat HD Cntrsunk	2	
63	R322-5	01-178-0508, 20-26-AD, 20-26-AGD, 30-9000, 322-5, 513341, 519755, 908019P, N/A	Bolt - Hex HD 5/16-18 x 1	2	
64	R3255-9	3255-9	Washer - Lock 3/8 Ext. Star	4	
65	R3253-3	01-166-0070, 01-166-0410, 23-9-GD, 24-7150, 3253-3, 3256-1, 352-167	Washer - Lock 1/4	4	
66	R443102	01-188-0420, 22-11-AJD, 3217-5, 33024-00	Nut - 1/4-20 Yellow Zinc	2	
66	R301504	2296-42, 301504, 32127-24, 32128-33, 32146-17, 3296-16, 3296-42, 3296-42, 915661P	Locknut - ESNA 1/4-20	2	
67	R3243-13	3243-13	Screw - Bed Bar Adjusting	4	
68	R12-0460	12-0460	Caplug - End Cap	1	
69	R323-2	01-178-0604, 323-2	Bolt - Hex HD 3/8-16 x 1	1	

All original equipment manufacturers names and part numbers are used for identification purposes only, and we are in no way implying that our products are original equipment parts. Prices subject to change without notice.



Replaces Toro Greensmaster 300 Parts

4-Bolt Cutting Unit - Models 04404, 04405, 04406, 04407,

04408 & 04409

Reel & Bedknife



Item No	R&R Part No.	OEM Part No.	Description	Qty Req	Order Quantity
70	R10-5080	10-5080, 10-5080-01	End - Cap Reel Brg Housing	1	
71	R10-5120	10-5120	Housing - Bearing Reel	2	
<i>Tech Note: Includes R253-96 & R254-72:</i>					
72	R302-40	302-13, 302-40	Fitting - Grease	1	
73	R325-5	01-150-0250, 01-178-0810, 19-8000, 20-86-AGD, 3226-1, 325-5, 513375	Bolt - Hex HD 1/2-13 x 1-1/4	2	
73	R3233-26	3233-26	Bolt - Carriage 1/2-13 x 1-1/4	2	
74	R3253-7	01-166-0030, 01-166-0080, 01-166-0290, 01-166-0810, 23-13-GD, 3253-7, 48-9380	Washer - Lock 1/2	2	
75	R443118	01-188-0813, 22-15-AJD, 3217-9	Nut - 1/2-13 Zinc	2	
76	R104-3399	104-3399	Housing Assy - Bearing Reel	2	
77	R3290-125	3290-125	Screw - Set 1/4-20 x 5/16	2	
80	R36-7250	22-7070, 36-7250, 37-8130, Oct-30	Grass Basket	3	

All original equipment manufacturers names and part numbers are used for identification purposes only, and we are in no way implying that our products are original equipment parts. Prices subject to change without notice.



Replaces Toro Greensmaster 300 Parts

4-Bolt Cutting Unit - Models 04404, 04405, 04406, 04407,
04408 & 04409
Reel & Bedknife



Item No	R&R Part No.	OEM Part No.	Description	Qty Req	Order Quantity
88	R254-72	01-103-0050, 01-103-0120, 01-103-0140, 1-543508, 254-71, 254-72, 40439, 62-3340, 99-4511	Cup - Bearing	2	
89	R254-94	1-543509, 254-94, 32-8090, 32-8240, 32-9640, 40440, 62-3330	Tapered Bearing Cone	2	
90	R94-2958	94-2958	Stud - Alloy Ball Joint	2	
91	R3254-6	01-166-0010, 01-166-0280, 01-166-0610, 3253-5, 3254-18, 3254-6, 3290-223, 48-9370	Washer - Lock 3/8	2	
92	R256-116	256-116	Bushing - Flanged	4	

All original equipment manufacturers names and part numbers are used for identification purposes only, and we are in no way implying that our products are original equipment parts. Prices subject to change without notice.