

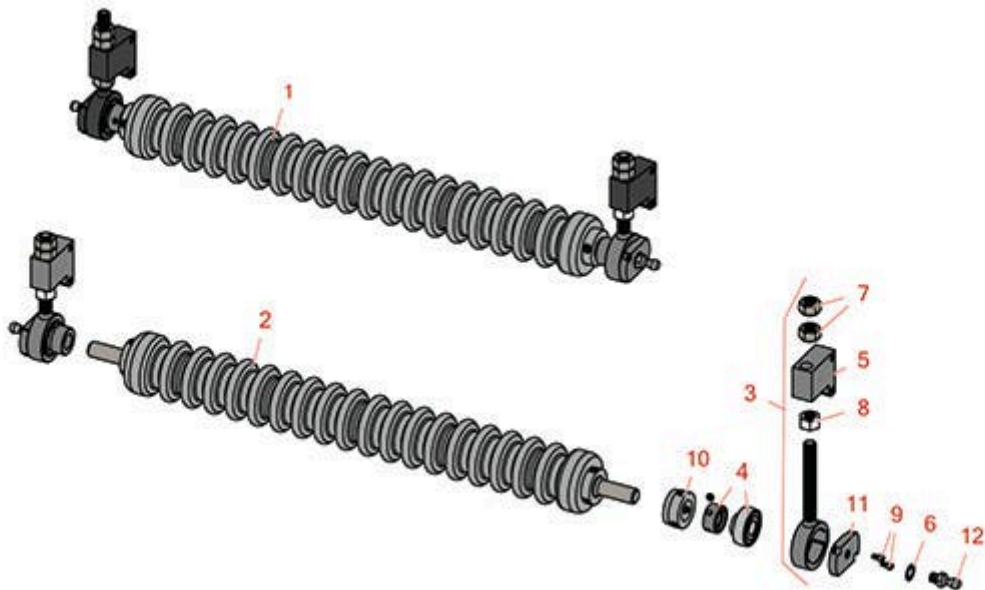

# Replaces Toro Greensmaster 300 Parts

4-Bolt Cutting Unit - Models 04404, 04405, 04406, 04407,  
04408 & 04409

Minuteman Roller System



All original equipment manufacturers names and part numbers are used for identification purposes only, and we are in no way implying that our products are original equipment parts. Prices subject to change without notice.



# Replaces Toro Greensmaster 300 Parts

4-Bolt Cutting Unit - Models 04404, 04405, 04406, 04407,  
04408 & 04409

Minuteman Roller System



Item No	R&R Part No.	OEM Part No.	Description	Qty Req	Order Quantity
<b>Complete Minuteman Roller Systems</b>					
1	<b>RMT8001</b>		Minuteman Front Grooved Roller System	0	
<i>Tech Note: Complete roller systems include roller and two brackets with bearings.:</i>					
<b>Minuteman Rollers Only</b>					
2	<b>RM513</b>		Minuteman Grooved Roller Only	0	
<i>Tech Note: Use with Minuteman Roller Bracket System Only:</i>					
<b>Other Parts Available</b>					
3	<b>RT821</b>		Bracket Assy - Front LH/RH	0	
<i>Tech Note: Includes RT8210 Bearing &amp; Locking Collar, RMM606 Washer, R3219-5 Nut &amp; RMM607 Screw:</i>					
4	<b>RMMB157</b>		Bearing w/Locking Collar	0	
5	<b>RT8210</b>		Block - Height Adj	0	
6	<b>RMM606</b>		Washer - Lock 3/8 Zinc Internal Tooth	0	
7	<b>R3219-5</b>	01-188-0820, 22-15-BJD, 22-15-BJKD, 3219-5	Nut - 1/2-20	0	
8	<b>RMM607</b>	01-158-0610, 01-191-0820, 21-3900, 3220-5, 45-0170, 5/1/3220	Nut - Jam 1/2-20 Zinc	0	
9	<b>RMM608</b>		Screw - 8-32 x 5/16 SS Socket Head	0	
10	<b>RMM3</b>		End Hub - 7/8 ID	0	
11	<b>RT821P</b>		Plate - For RT821 Bracket	0	

All original equipment manufacturers names and part numbers are used for identification purposes only, and we are in no way implying that our products are original equipment parts. Prices subject to change without notice.



# Replaces Toro Greensmaster 300 Parts

4-Bolt Cutting Unit - Models 04404, 04405, 04406, 04407,  
04408 & 04409

*Minuteman Roller System*



Item No	R&R Part No.	OEM Part No.	Description	Qty Req	Order Quantity
12	<b>RT821B</b>		Ball - For RT821 Bracket	0	

All original equipment manufacturers names and part numbers are used for identification purposes only, and we are in no way implying that our products are original equipment parts. Prices subject to change without notice.