



Replaces John Deere 7700A Reel Mower

Parts

Verti-Cut Unit

Verti-Cut Reel & Frame

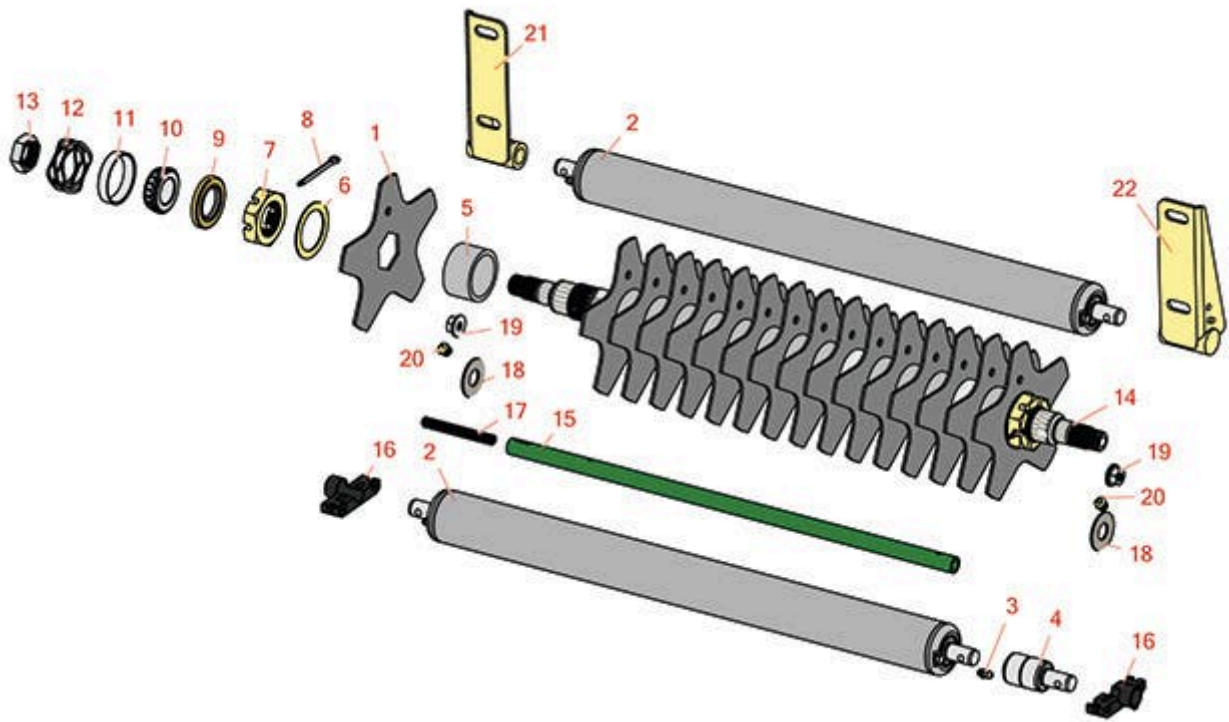

All original equipment manufacturers names and part numbers are used for identification purposes only, and we are in no way implying that our products are original equipment parts. Prices subject to change without notice.



Replaces John Deere 7700A Reel Mower Parts

Verti-Cut Unit
Verti-Cut Reel & Frame



Item No	R&R Part No.	OEM Part No.	Description	Qty Req	Order Quantity
Verti-Cut Blades					
1	RMT6987	MT6987	Verti-Cut Blade	16	
Other Parts Available					
2	RAET11263	AET11263, AMT2967	Roller - Smooth Tubular Steel	1	
<i>Tech Note: Constructed with a through shaft, this heavy duty roller uses greasable tapered bearings for extended life.:</i>					
2	RAET10111	AET10111, AMT2876	Roller - Smooth Tubular Steel	2	
<i>Tech Note: This tubular steel roller uses greasable "water-pump" style bearings.:</i>					
3	R471219	471219, JD7759, JD7798	Zerk - Grease	2	
4	RAA35741	AA35741, AET10129, TCA22836	Bearing	2	
<i>Tech Note: 1/4" Side Hole:</i>					
5	RET17648	ET17648	Spacer	15	
6	R24H1549	24H1549	Spacer	14	
7	RET17318	ET17318	Nut - Slotted Jam	2	
8	R11M7032		Pin - Cotter	2	
9	RTC25266	TCU25266	Seal	2	
10	R254-94	JD8933, TCU37582	Tapered Bearing Cone	2	
11	R254-72	JD8253	Cup - Bearing	2	
12	R170610	TCU26530	Spring - Compression	1	

All original equipment manufacturers names and part numbers are used for identification purposes only, and we are in no way implying that our products are original equipment parts. Prices subject to change without notice.



Replaces John Deere 7700A Reel Mower Parts

Verti-Cut Unit
Verti-Cut Reel & Frame



Item No	R&R Part No.	OEM Part No.	Description	Qty Req	Order Quantity
13	RTC26215	TCU26215	Nut - Reel	2	
14	RMT770	MT770	Shaft - Verti-Cut	1	
15	RTC26729	TCU26729	Tube	1	
16	RTC28987	TCU28987	Half Clamp - Roller Bkt	2	
17	RTC25398	TCU25398	Compression Spring	1	
18	RET16424	ET16424	Washer	4	
19	RH135891	H135891	Locknut - 10mm x 1.5 Flanged 10.9	2	
<i>Tech Note: High Strength:</i>					
20	R170714	E14814	Fitting - Pressure Relief	2	
21	RAMT5050	AMT5050	Bracket - Roller - V-Cut Unit	1	
22	RAMT5051	AMT5051	Bracket - Roller - V-Cut Unit	1	

All original equipment manufacturers names and part numbers are used for identification purposes only, and we are in no way implying that our products are original equipment parts. Prices subject to change without notice.