



Replaces Jacobsen Greens King 522

Parts

Cutting Unit

Minuteman Roller System

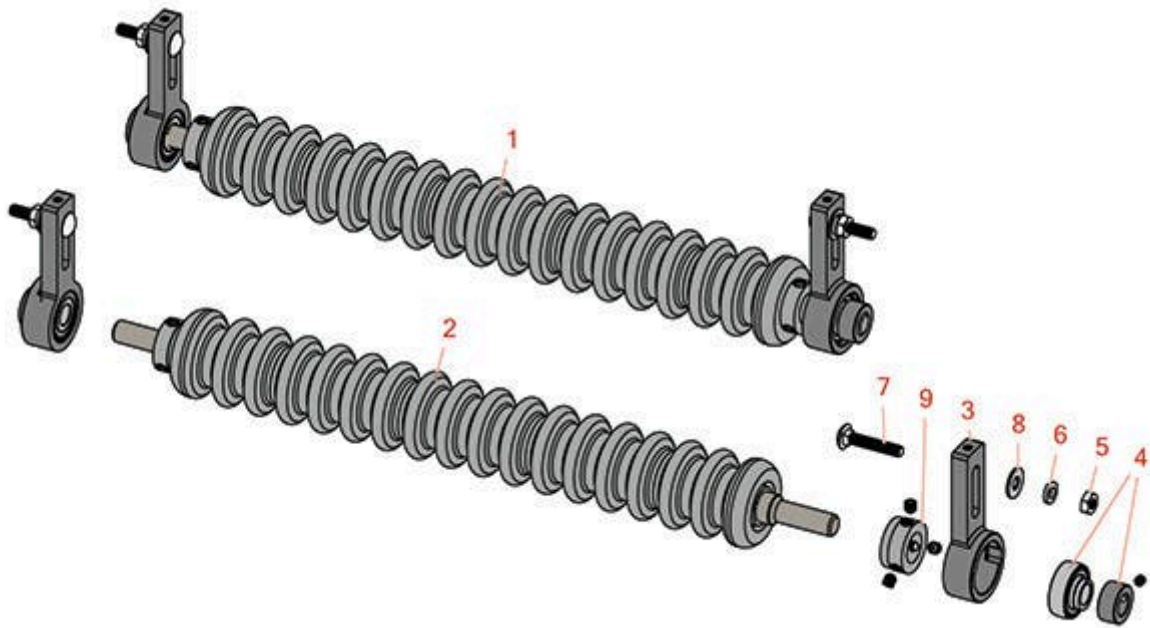

All original equipment manufacturers names and part numbers are used for identification purposes only, and we are in no way implying that our products are original equipment parts. Prices subject to change without notice.



Replaces Jacobsen Greens King 522

Parts

Cutting Unit

Minuteman Roller System



Item No	R&R Part No.	OEM Part No.	Description	Qty Req	Order Quantity
---------	--------------	--------------	-------------	---------	----------------

Complete Minuteman Roller Systems

1	RMJ2201		Minuteman Front 22" Grooved Roller System	0	
---	----------------	--	---	---	--

Tech Note: Complete roller systems include roller and two brackets with bearings.:

1	RMJ2401		Minuteman Front 18" Grooved Roller System	0	
---	----------------	--	---	---	--

Tech Note: Complete roller systems include roller and two brackets with bearings.:

Minuteman Rollers Only

2	RM511		Minuteman Grooved Roller Only - 22 in	1	
---	--------------	--	---------------------------------------	---	--

Tech Note: Use with Minuteman Roller Bracket System Only:

2	RM5050		Minuteman Grooved Roller Only - 18 in	1	
---	---------------	--	---------------------------------------	---	--

Tech Note: Use with Minuteman Roller Bracket System Only:

Other Parts Available

3	RJ221		Bracket - Front LH / RH	2	
---	--------------	--	-------------------------	---	--

4	RMMB157		Bearing w/Locking Collar	2	
---	----------------	--	--------------------------	---	--

5	R443106	443106	Nut - 5/16-18 Y/Zinc Plated	2	
---	----------------	--------	-----------------------------	---	--

6	R446136	446134, 446136	Washer - Lock 5/16 Zinc	2	
---	----------------	-------------------	-------------------------	---	--

7	R441674	441674	Screw - 5/16-18 x 1-3/4 Carriage	2	
---	----------------	--------	----------------------------------	---	--

8	R310266	310266, 452004, 452006, 452008	Washer - Flat 5/16 USS	2	
---	----------------	---	------------------------	---	--

9	RMM3		End Hub - 7/8 ID	2	
---	-------------	--	------------------	---	--

All original equipment manufacturers names and part numbers are used for identification purposes only, and we are in no way implying that our products are original equipment parts. Prices subject to change without notice.