

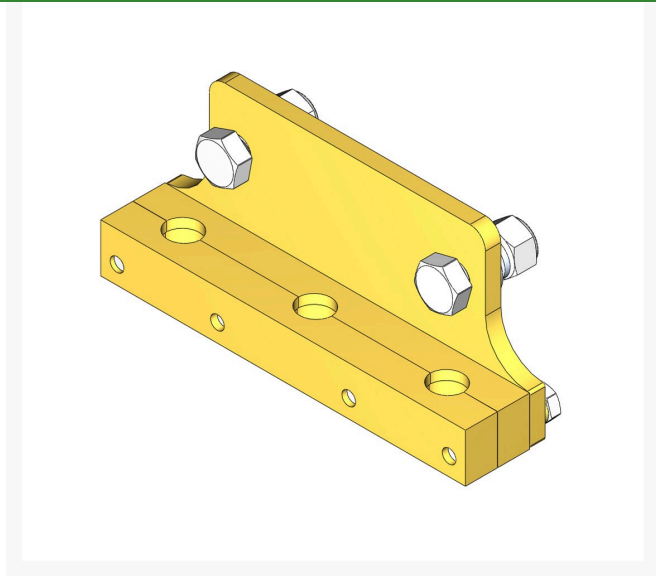

Tine Holder Assy - 3 Tine 7/8 Mt

R100-7618



Replaces

Toro 100-7618

Specifications

Manufacturer R&R Products

Fits Models

Toro ProCore 440

Toro ProCore 660

Toro ProCore 880

Replacement Parts

R33028-00	Locknut - 16mm x 2.0 ESNA
R33098-00	Flatwasher - 16mm
R33115-050	Bolt - Hex HD M10-1.5 x 50
R33118-045	Bolt - Hex HD M16-2.0 x 45
R48-9590	Washer - Lock 10mm

O.J. Company

294 Rang St-Paul Sherrington, J0L 2N0
450-247-2758

<https://ojcompagnie.rrproducts.com/>