

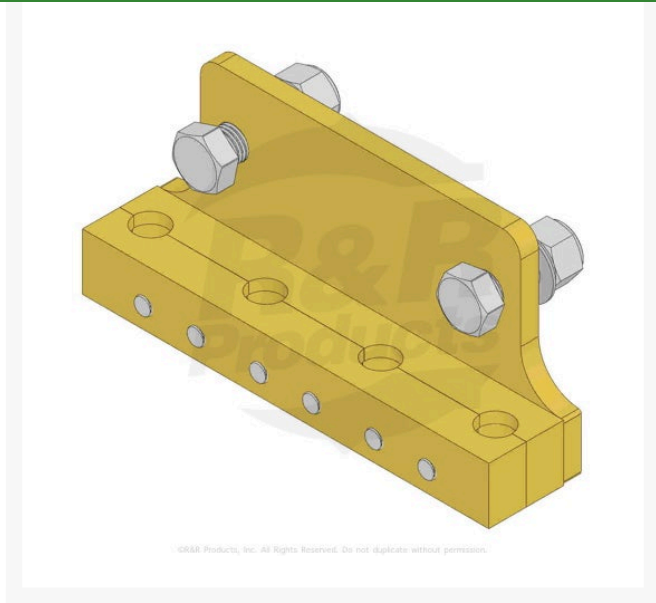

Tine Holder Assy - 4 Tine 3/4 Mt

R100-3696



Replaces

Toro 100-3696

Specifications

Manufacturer R&R Products

Fits Models

Toro ProCore 440
Toro ProCore 660
Toro ProCore 880

Replacement Parts

R33028-00	Locknut - 16mm x 2.0 ESNA
R33098-00	Flatwasher - 16mm
R33115-050	Bolt - Hex HD M10-1.5 x 50
R33118-045	Bolt - Hex HD M16-2.0 x 45
R48-9590	Washer - Lock 10mm

O.J. Company

294 Rang St-Paul Sherrington, J0L 2N0
450-247-2758

<https://ojcompagnie.rrproducts.com/>