

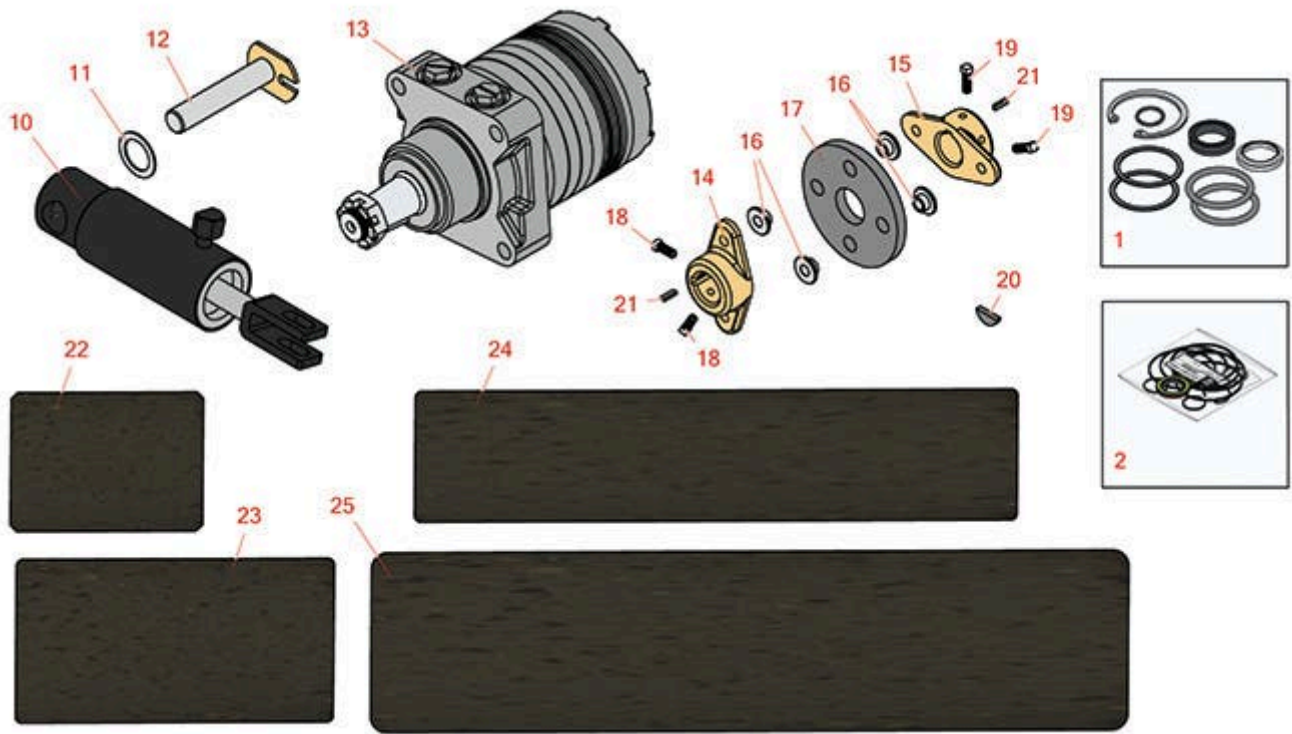

Replaces Toro Greensmaster 300 Parts

Traction Unit - Model 04345

Hydraulic Motor & Cylinder



All original equipment manufacturers names and part numbers are used for identification purposes only, and we are in no way implying that our products are original equipment parts. Prices subject to change without notice.



Replaces Toro Greensmaster 300 Parts

Traction Unit - Model 04345

Hydraulic Motor & Cylinder



Item No	R&R Part No.	OEM Part No.	Description	Qty Req	Order Quantity
---------	--------------	--------------	-------------	---------	----------------

Overhaul Kits

1	R83-7000SK	56-3810, 56-3820, 70-2790, 83-7250, 86-5260, 86-5360	Seal Kit - Fits R83-7000 Cylinder	1	
---	-------------------	---	-----------------------------------	---	--

Tech Note: Includes Seals, O-Rings & 1 ea: R43-5220 Retaining Ring to rebuild one cylinder:

1	R63-9500SK		Seal Kit - Fits R63-9500 Cylinder	1	
1	R83-6820SK		Seal Kit - Fits R83-6820 Cylinder	1	
1	R43-5260SK		Seal Kit - Fits Hyd Cylinder	1	
1	R68-9700SK		Seal Kit - Fits R68-9700 Cylinder	1	
1	R51-0120SK		Seal Kit - Fits R51-0120 Cylinder	1	
2	R76-0800	100-6131, 76-0800, 94-8178	Seal Kit - Hyd Wheel Motor	1	
2	R353-461	353-461	Seal Kit - Wheel Motor	2	

Other Parts Available

10	R84-8290	10-7900, 353-442, 353-443, 353-448, 353-449, 46-3690, 46-4890, 51-0120, 51-0130, 63-9500, 75-9880, 83-1250, 83-6820, 84-8290	Hydraulic Cylinder - Front	1	
----	-----------------	---	----------------------------	---	--

All original equipment manufacturers names and part numbers are used for identification purposes only, and we are in no way implying that our products are original equipment parts. Prices subject to change without notice.



Replaces Toro Greensmaster 300 Parts

Traction Unit - Model 04345

Hydraulic Motor & Cylinder



Item No	R&R Part No.	OEM Part No.	Description	Qty Req	Order Quantity
10	R83-7000	27-2510, 43-5260, 68-9700, 83-7000	Hydraulic Cylinder	1	
11	R10-8110	10-8110	Washer - Pivot Pin	0	
12	R10-6060	10-6060, 120-3199	Pin - Pivot 3-7/8 Long	1	
13	R10-8010	10-8010	Hydraulic Motor	2	
14	R27-1960	110-5236, 27-1960	Hub - Engine	1	
15	R27-1970	27-1970	Hub - Pump	1	
16	R27-6600	27-6600	Spacer - Pump Coupling	4	
17	R44-2230	115-4523, 27-6560, 44-2230, 80-8650	Coupling - Rubber - Pump	1	
18	R3241-2	01-163-0100, 31-6770, 3241-1, 3241-2	Screw - Set Sq.HD. 1/4 x 5/8	2	
19	R3241-6	3241-6	Screw - Set Sq. HD. 1/4 x3/4	2	
20	R463009	5-0946	Key - Spindle Shaft	1	
21	R1164	10-7070, 48-004-1931, 62-3380, 66-004-3221, 85-9020	Key - 1/4 x 1/4 x 1	1	
22	R10-8200	10-8200	Pad - Anti-Skid Foot Step	1	
23	R62-2660	62-2660	Pad - Anti-Skid Foot Step	1	
24	R10-8220	10-8220	Pad - Anti-Skid Tool Box	1	

All original equipment manufacturers names and part numbers are used for identification purposes only, and we are in no way implying that our products are original equipment parts. Prices subject to change without notice.



Replaces Toro Greensmaster 300 Parts

Traction Unit - Model 04345

Hydraulic Motor & Cylinder



Item No	R&R Part No.	OEM Part No.	Description	Qty Req	Order Quantity
25	R49-6120	10-8210, 49-6120	Pad - Anti-Skid Foot Rest	1	

All original equipment manufacturers names and part numbers are used for identification purposes only, and we are in no way implying that our products are original equipment parts. Prices subject to change without notice.